

CLEAR ANODIZED ALUMINIUM.
FIXED TO BACK OF FRONTAL AND
DIVISION

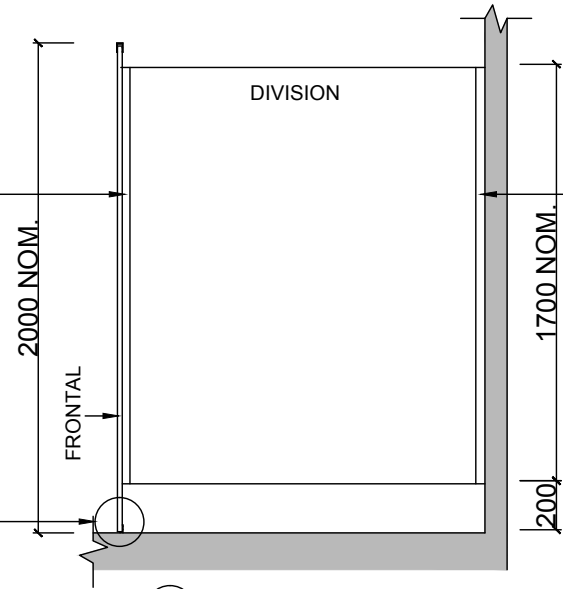

CLEAR ANODIZED ALUMINIUM
CHANNEL. FIXED TO BACK WALL
AND DIVISION

1 SECTION ELEVATION

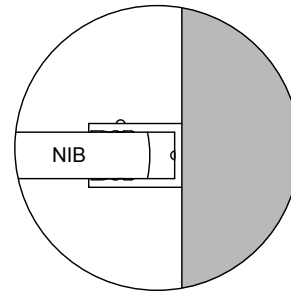
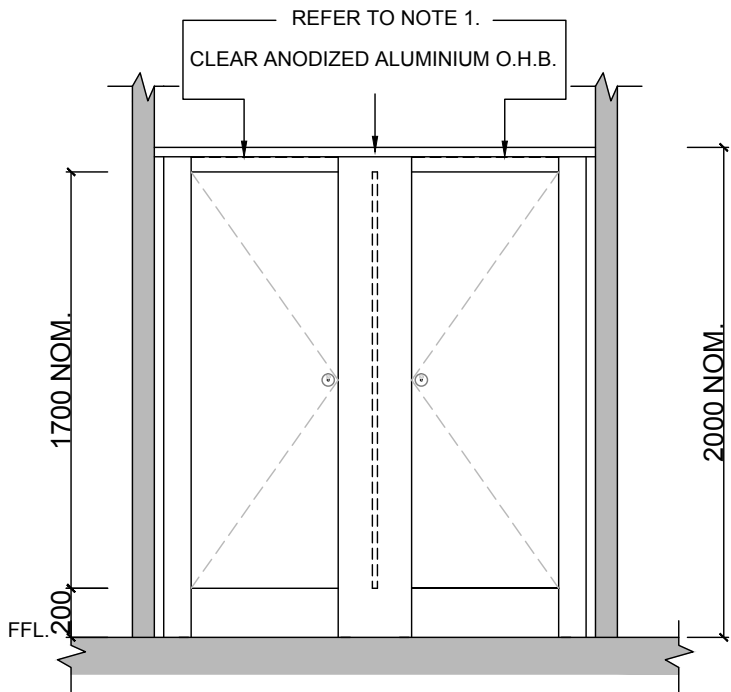

1 DETAIL 1

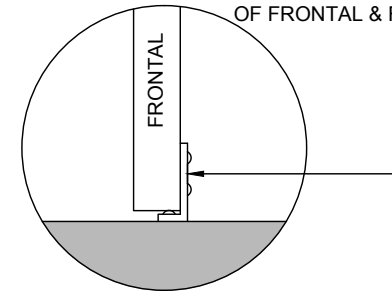

1 DETAIL 2

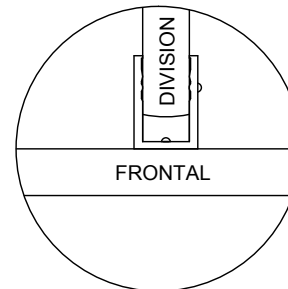

1 DETAIL 3

| | | | |
|--------------|--|-----------|---|
| SYSTEM TYPE: | FLOOR MOUNTED, OVER HEAD BRACED 19mm TOILET PARTITIONS | | |
| MATERIAL: | 19mm NUVEX® SANIBOARD | | |
| DATE: | 11.12.13 | REVISION: | 1 |
| NOT TO SCALE | USE FIGURED DIMENSIONS. DO NOT SCALE OFF DRAWING. THIS DESIGN IS COPYRIGHT AND MAY NOT BE REPRODUCED WITHOUT THE WRITTEN PERMISSION OF THE DESIGNER. | | |

NUVEX[®]
ARCHITECTURAL PRODUCTS

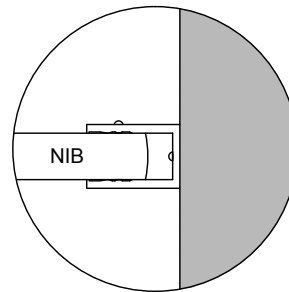
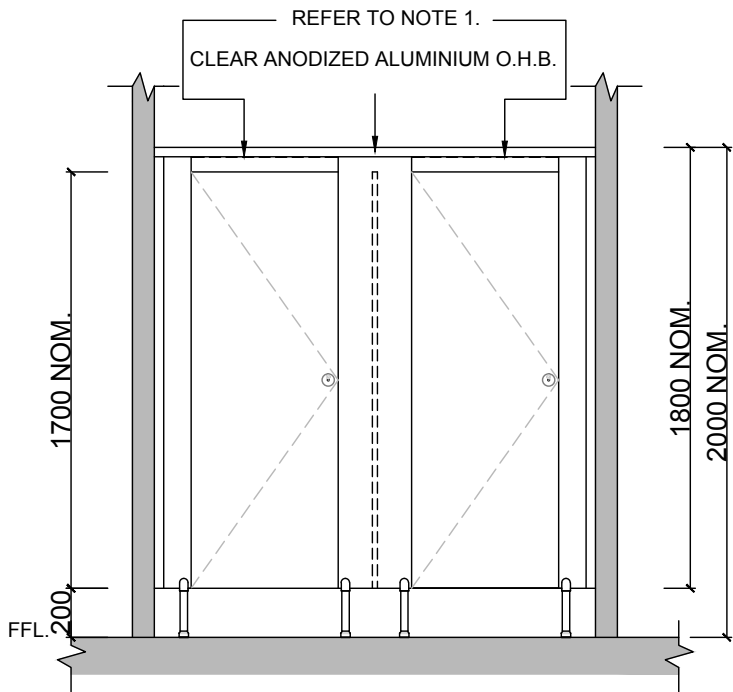
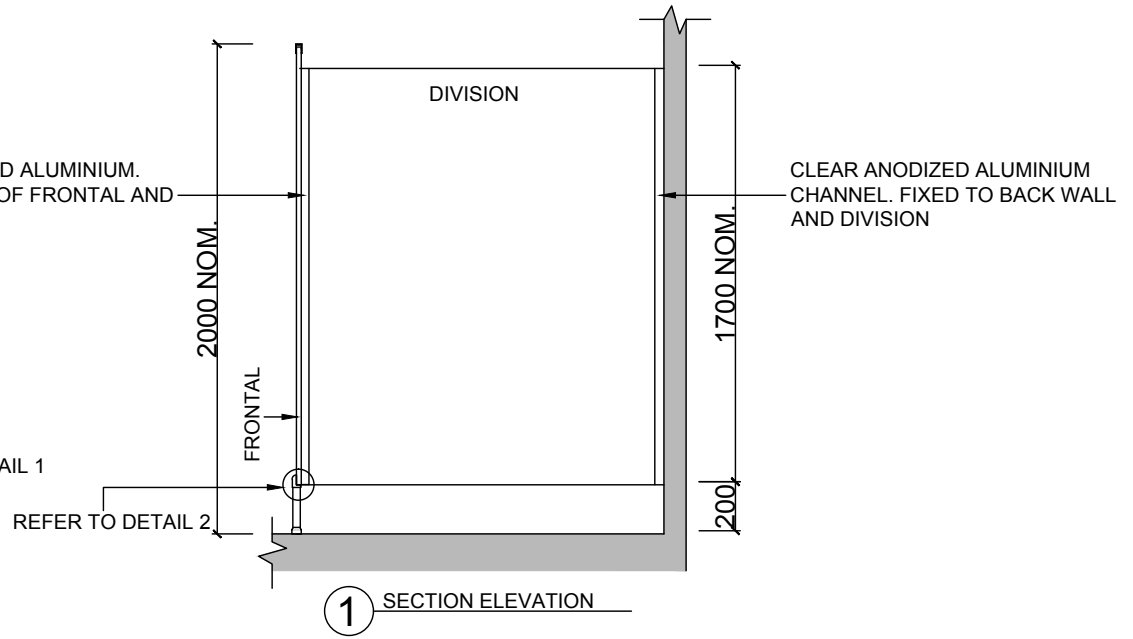
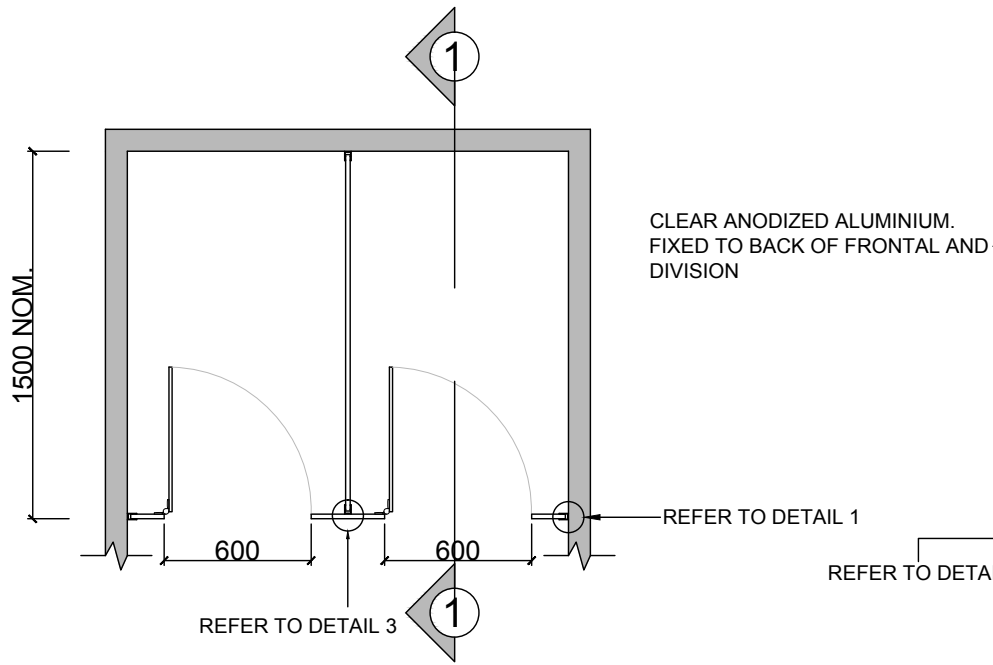

1 DETAIL 1

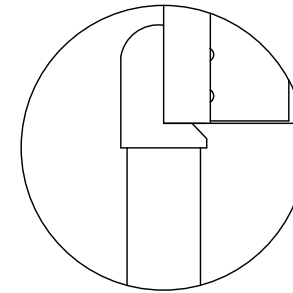

2 DETAIL 2

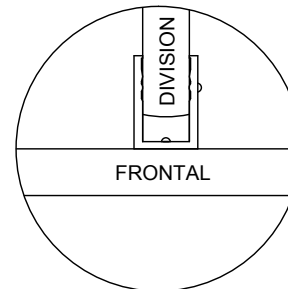

3 DETAIL 3

| | | | |
|--------------|--|-----------|---|
| SYSTEM TYPE: | PEDESTAL MOUNTED, OVER HEAD BRACED 19mm TOILET PARTITIONS | | |
| MATERIAL: | 19mm NUVEX® SANIBOARD | | |
| DATE: | 11.12.13 | REVISION: | 1 |
| NOT TO SCALE | USE FIGURED DIMENSIONS. DO NOT SCALE OFF DRAWING. THIS DESIGN IS COPYRIGHT AND MAY NOT BE REPRODUCED WITHOUT THE WRITTEN PERMISSION OF THE DESIGNER. | | |

NUVEX[®]
ARCHITECTURAL PRODUCTS

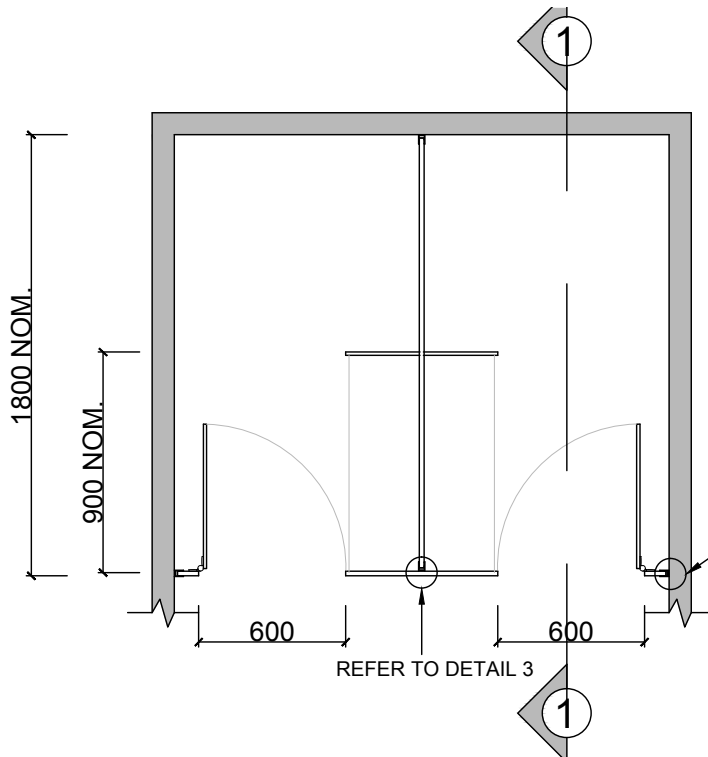

CLEAR ANODIZED ALUMINIUM CHANNEL. FIXED TO BACK OF FRONTAL AND DIVISION

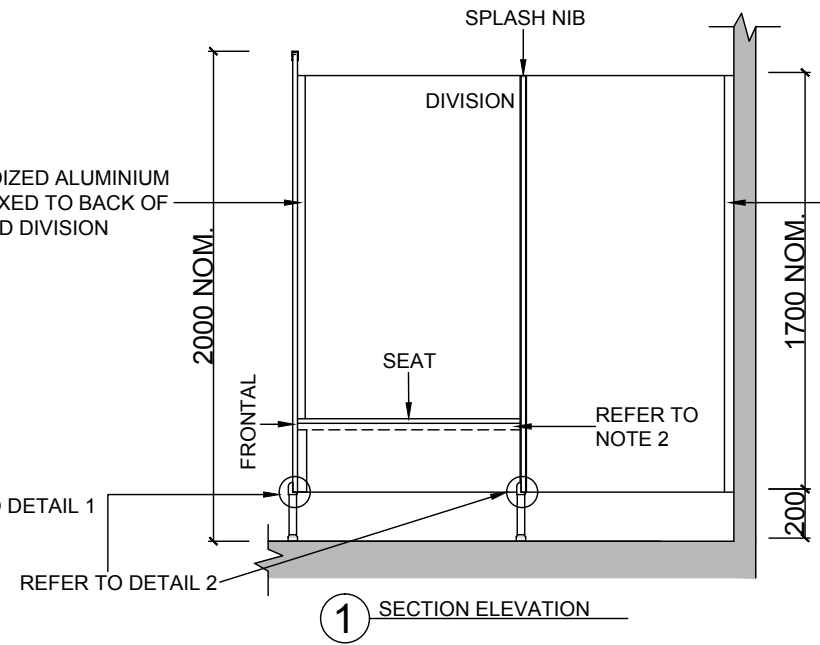

CLEAR ANODIZED ALUMINIUM CHANNEL. FIXED TO BACK WALL AND DIVISION

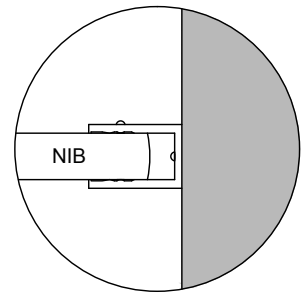
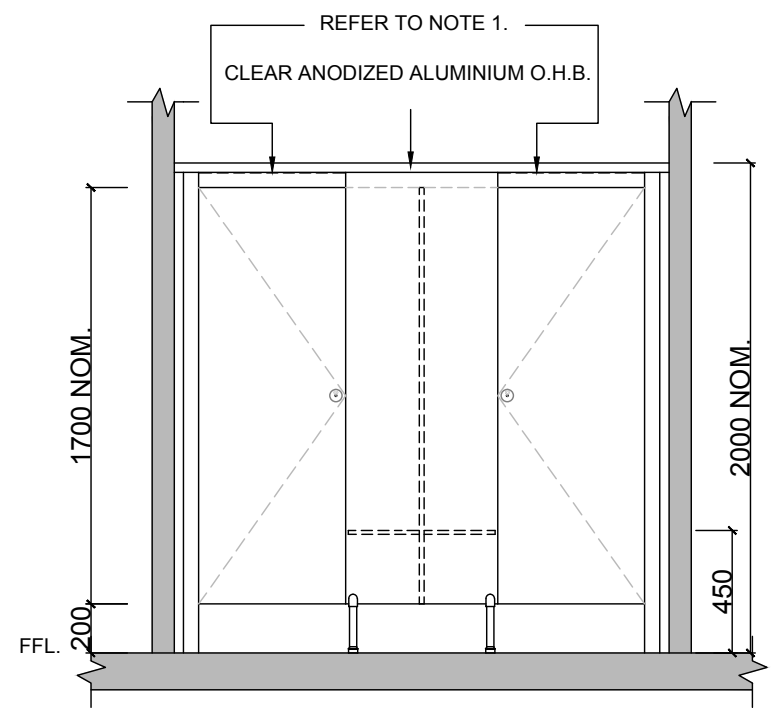

1 DETAIL 1

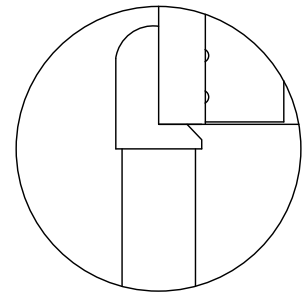

2 DETAIL 2

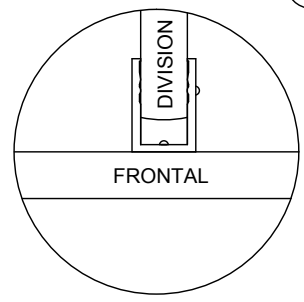

3 DETAIL 3

| | | | |
|--------------|--|-----------|---|
| SYSTEM TYPE: | PEDESTAL MOUNTED, OVER HEAD BRACED 19mm SHOWER PARTITIONS | | |
| MATERIAL: | 19mm NUVEX® SANIBOARD | | |
| DATE: | 11.12.13 | REVISION: | 1 |
| NOT TO SCALE | USE FIGURED DIMENSIONS. DO NOT SCALE OFF DRAWING. THIS DESIGN IS COPYRIGHT AND MAY NOT BE REPRODUCED WITHOUT THE WRITTEN PERMISSION OF THE DESIGNER. | | |

NUVEX[®]
ARCHITECTURAL PRODUCTS

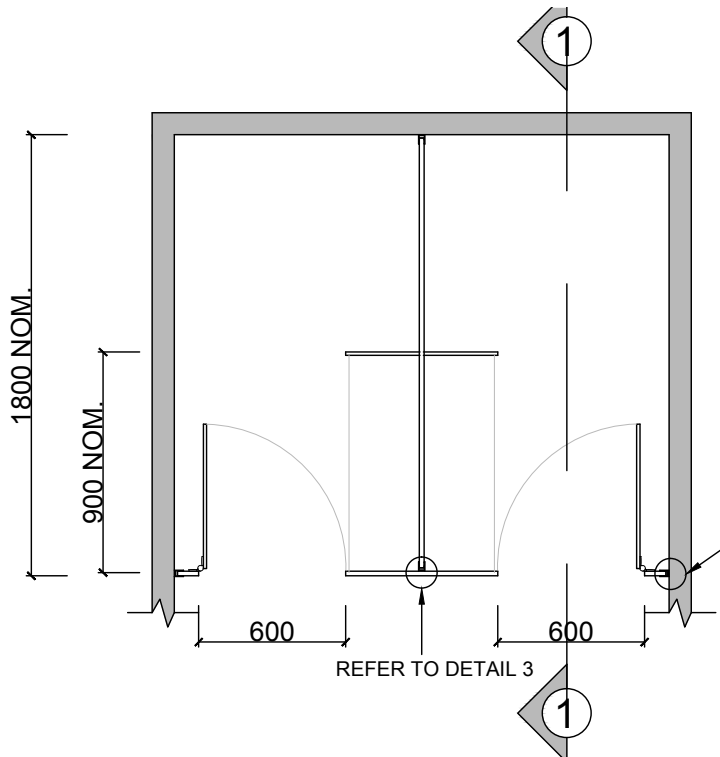

CLEAR ANODIZED ALUMINIUM CHANNEL. FIXED TO BACK OF FRONTAL AND DIVISION

REFER TO DETAIL 1

REFER TO DETAIL 2

REFER TO DETAIL 3

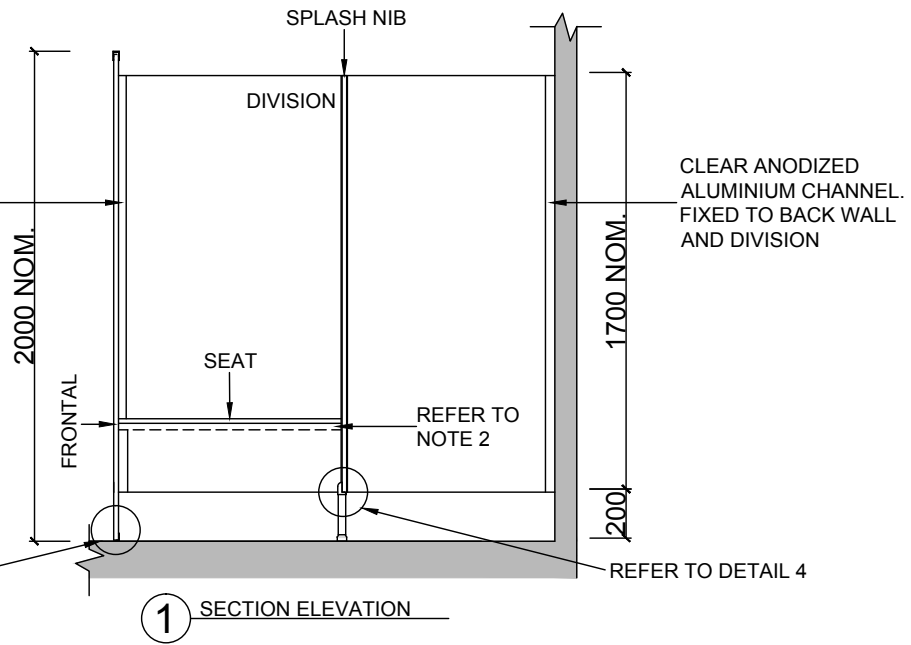

1 SECTION ELEVATION

CLEAR ANODIZED ALUMINIUM CHANNEL. FIXED TO BACK WALL AND DIVISION

REFER TO NOTE 2

REFER TO DETAIL 4

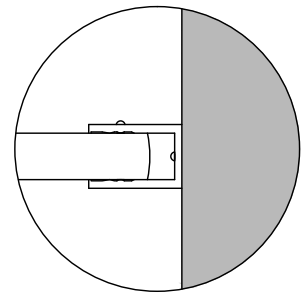
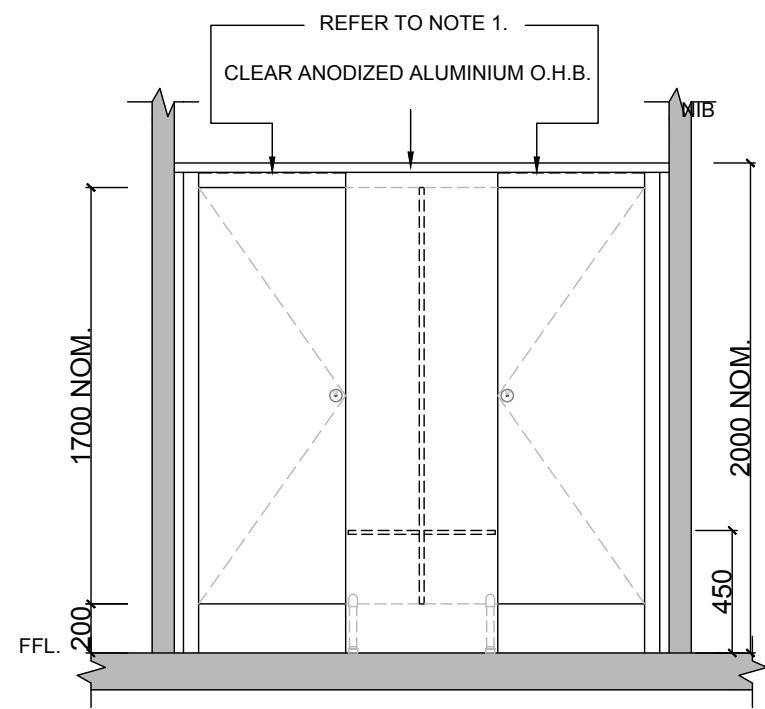

1 DETAIL 1

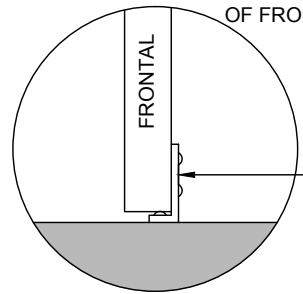

2 DETAIL 2

32 x 12 x 3mm CLEAR ANODIZED ALUMINIUM ANGLE FIXED TO BACK OF FRONTAL & FLOOR.

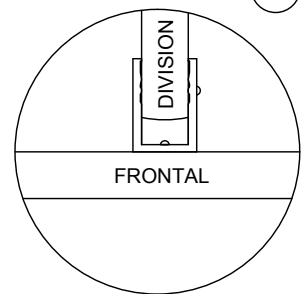

3 DETAIL 3

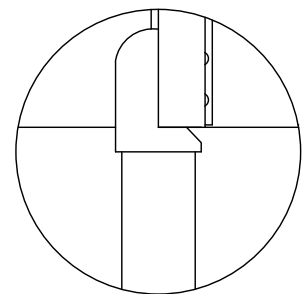

4 DETAIL 4

| | | | |
|--------------|--|-----------|---|
| SYSTEM TYPE: | FLOOR MOUNTED, OVER HEAD BRACED 19mm SHOWER PARTITIONS | | |
| MATERIAL: | 19mm NUVEX® SANIBOARD | | |
| DATE: | 11.12.13 | REVISION: | 1 |
| NOT TO SCALE | USE FIGURED DIMENSIONS. DO NOT SCALE OFF DRAWING. THIS DESIGN IS COPYRIGHT AND MAY NOT BE REPRODUCED WITHOUT THE WRITTEN PERMISSION OF THE DESIGNER. | | |

NUVEX[®]
ARCHITECTURAL PRODUCTS